



# DNH

HEAD OFFICE, NORWAY  
DNH AS

Phone..... + 47 35 98 56 00  
Fax..... + 47 35 98 56 10  
E-mail..... dnh@dnh.no  
Web-Site..... www.dnh.no

ENGLAND  
DNH WW Ltd  
Phone..... + 44 1908 275 000  
Fax..... + 44 1908 275 100  
E-mail..... dnh@dnh.co.uk

GERMANY  
DNH GmbH  
Phone... + 49 040 6569 30-0  
Fax..... + 49 040 6569 30-30  
E-mail..... dnh@dnh.de

## DSP-15L(T)

USA  
DNH Speakers Inc  
Phone..... + 1 484 494 5790  
Fax..... + 1 484 494 5793  
E-mail..... dnh@dnhspeakers.com

ISO 9001 CERTIFIED

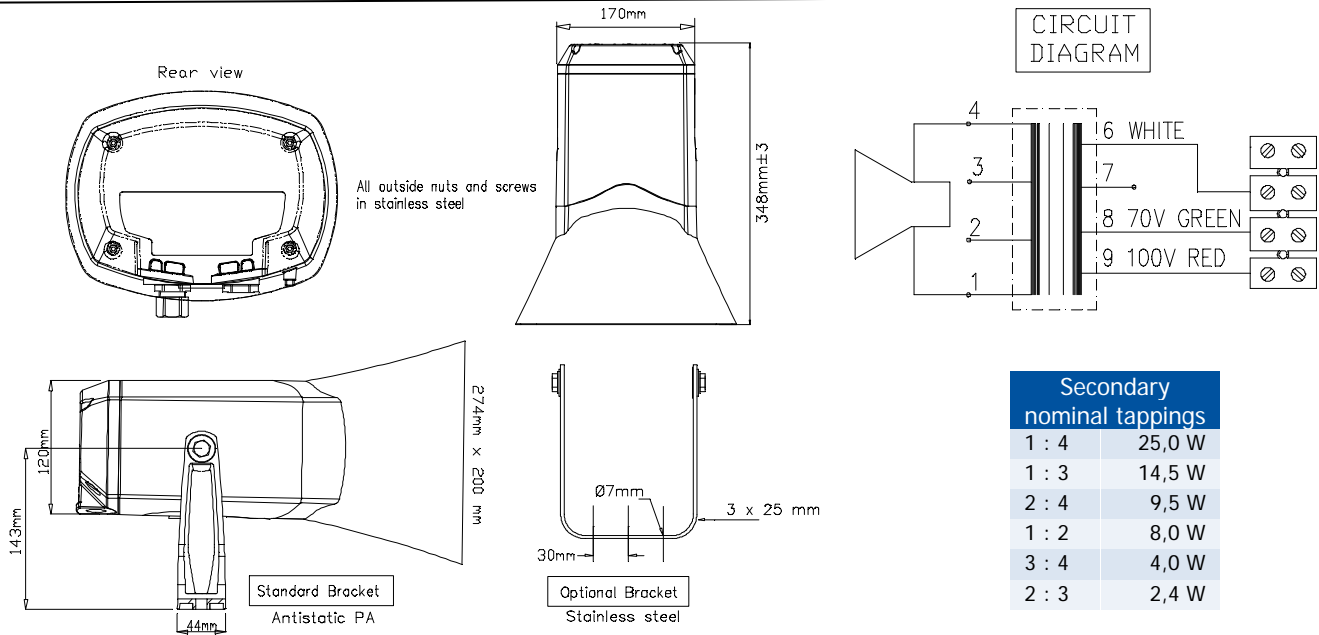

Sound pressure levels at 1W/1m  
**SPL vs Freq**



### Specifications

Material / Color	ASA / RAL 7035
Mounting	Bracket
Termination	Inside screw terminals
Weight w/transformer	1,9 kg
IP-rating	67
Max. / min. amb. temp	90°C / -50°C
Rated / max. power	25 W / 25 W
SPL 1W/1m	111 dB
SPL rated power	123 dB
Effective freq. range	290 –11000 Hz
Dispersion (-6dB) 1kHz / 4kHz	140° / 40°
Directivity factor, Q	3,8
Options	Impedances, colors, labels

### Installation, Operation and Maintenance Procedures

- Remove lid by four screws, lead cable through the cable gland and connect to terminal 70V (white – green) or 100V (white – red).
- Choose required power on the transformer.
- Screw lid back into place by four screws with a torque of 1 - 2 Nm to assure the IP rating.
- To change the position of the loudspeaker, please adjust the standard U- bracket (by loosening / tightening the screws) as required.
- DSP-15L(T) can be supplied with 3 different bracket systems, according to customer requirements.
- For optimum performance, always use the correct voltage / power and operate within the frequency limits as stated.
- Do not open loudspeaker when energized.
- This loudspeaker is supplied with a two years warranty against defective workmanship.
- Available with an aluminum swivel bracket.

DNH reserves the right to alter specifications without notice

