



DNH

HEAD OFFICE, NORWAY
DNH AS

Phone..... + 47 35 98 56 00
Fax..... + 47 35 98 56 10
E-mail..... dnh@dnh.no
Web-Site..... www.dnh.no

ENGLAND

DNH WW Ltd

Phone..... + 44 1908 275 000
Fax..... + 44 1908 275 100
E-mail..... dnh@dnh.co.uk

GERMANY

DNH GmbH

Phone... + 49 040 6569 30-0
Fax..... + 49 040 6569 30-30
E-mail..... dnh@dnh.de

DSP-15(T)

USA

DNH Speakers Inc

Phone..... + 1 484 494 5790
Fax..... + 1 484 494 5793
E-mail..... dnh@dnhspeakers.com

ISO 9001 CERTIFIED

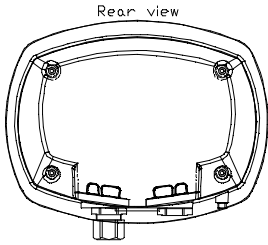

Rear view

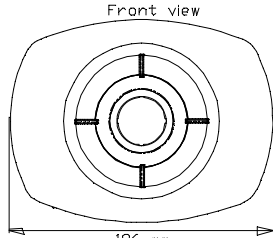

Front view

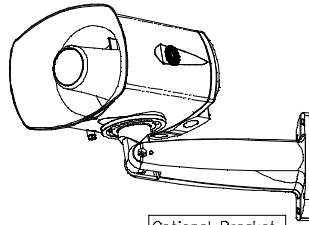

Optional Bracket
Antistatic plastic

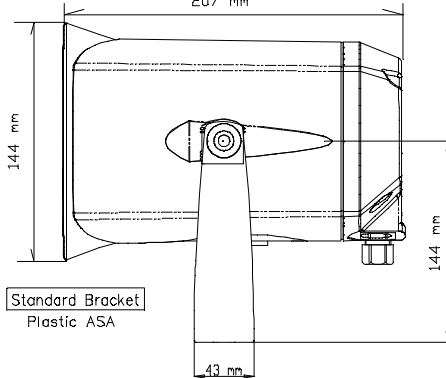
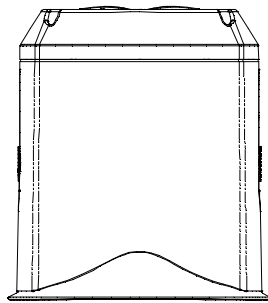

Standard Bracket
Plastic ASA

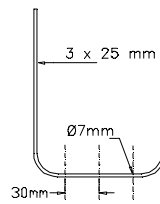

Optional Bracket
Stainless steel

Delivered with
1xM20 cable gland and
1xM20 blanking plug

CIRCUIT
DIAGRAM

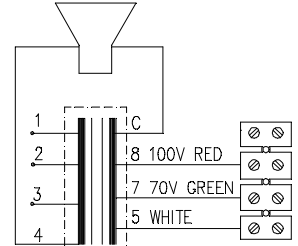

Secondary
nominal tapings

C : 1	15,0 W
C : 2	7,5 W
C : 3	4,0 W
C : 4	2,0 W

Low impedance

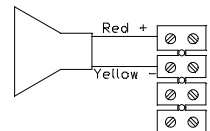

Sound pressure levels at 1W/1m (MP-28-54)

SPL vs Freq



Specifications

Material / Color	ASA / RAL 7035
Mounting	Bracket
Termination	screw terminals
Weight w/transformer	1,8 kg
IP-rating	67
Max. / min. amb. temp	90°C / -50°C
Rated / max. power	15 W / 20 W
SPL 1W/1m	106 dB
SPL rated power	117 dB
Effective freq. range	350 – 11000 Hz
Dispersion (-6dB) 1kHz / 4kHz	140° / 40°
Directivity factor, Q	1,8
Options	Impedances, colors, labels

Installation, Operation and Maintenance Procedures

- Remove lid by four screws, lead cable through the cable gland and connect to terminal (70V or 100V)
- Select required tapping on the transformer.
- Screw lid back into place by four screws with a torque of 1.3 – 1.8 Nm to assure the IP rating.
- To change the position of the loudspeaker, please adjust the standard U- bracket (by loosening / tightening the screws) as required.
- DSP-15(T) can be supplied with three different bracket systems, according to customer requirements.
- For optimum performance, always use the correct voltage / power and operate within the frequency limits as stated.
- Do not open loudspeaker when energized.
- This loudspeaker is supplied with a two years warranty against defective workmanship.

DNH reserves the right to alter specifications without notice

